

3V, 6V, 12V, 24V, High Speed DC Small Motor RS 130, 140, 180, 260, 280, 300, 310, 365, 380, 385, 390, 395, 500, 545, 550, 555, 775, 795, 895, Basic Info

Motor Info Table:

RS-130 3V-6V Miniature DC Brush Motor w/o Gear	
	
Dimension	Specification
	<ul style="list-style-type: none"> • Voltage: 3V-6V DC • Speed: 8600RPM @320mA • Torque: 1.37mN.m • Body Size: 1.18" x 0.66" • Shaft Size: 0.30" x 0.078"

RS-140 3V-6V High Speed DC Motor

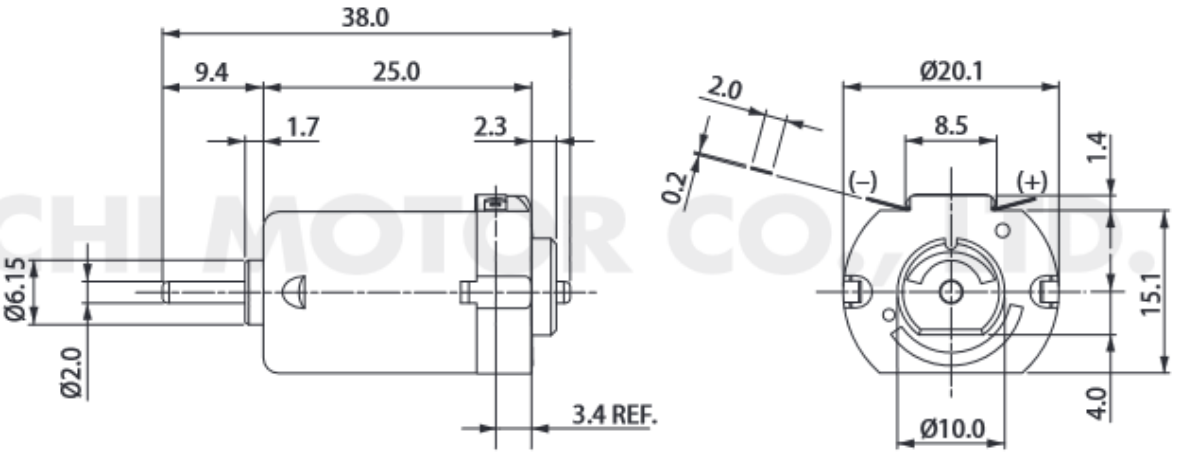

Dimension

Specification

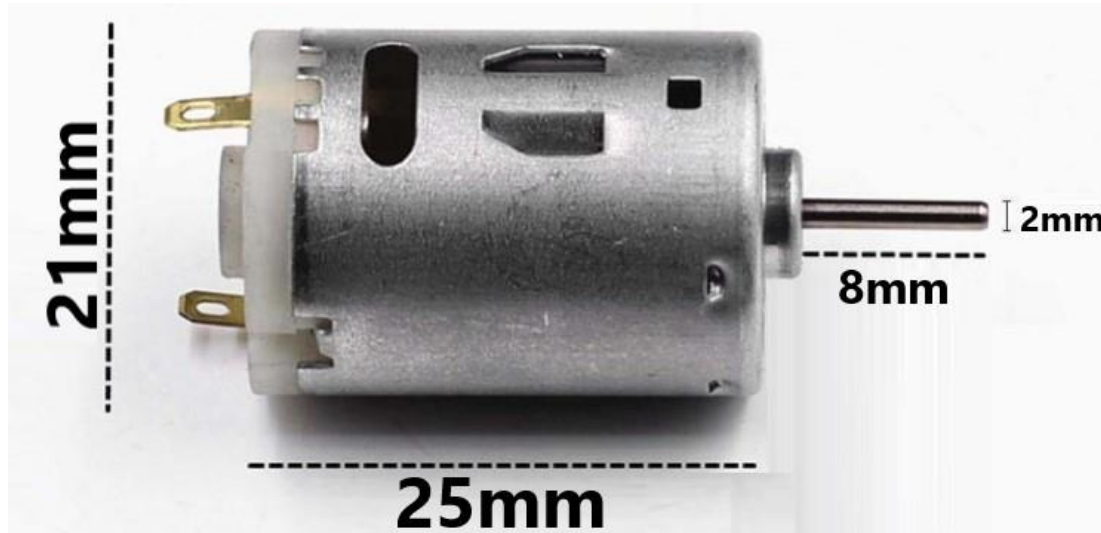

- Voltage: 3V-6V DC
- Speed: 5000-20000
- Body Size (dia x length): 21 x 25mm
- Shaft Size (dia x length): 2 x 8mm

RS-180 3V-6V High Speed DC Motor



Dimension

Specification



- Voltage: 3V-6V DC
- Speed: 12000-24000
- Body Size (LxWxH): 32 x 20 x 15mm
- Shaft Size (dia x length): 2 x 8.7mm

RS-260 3V-6V High Speed DC Motor



Dimension

Specification

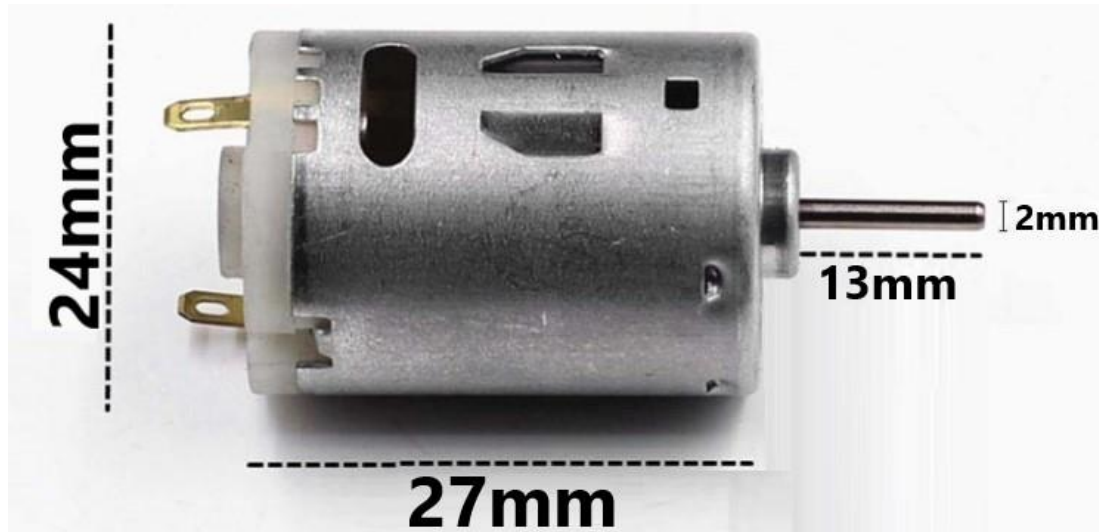

- Voltage: 3V-6V DC
- Speed: 3000-6550RPM
- Torque: 19.7 g.cm
- Body Size (dia x length): 24 X 27MM
- Shaft Size (dia x length): 2 X 13MM
- Weight: 56g

RS-280 3V-12V High Speed DC Motor



Dimension

Specification

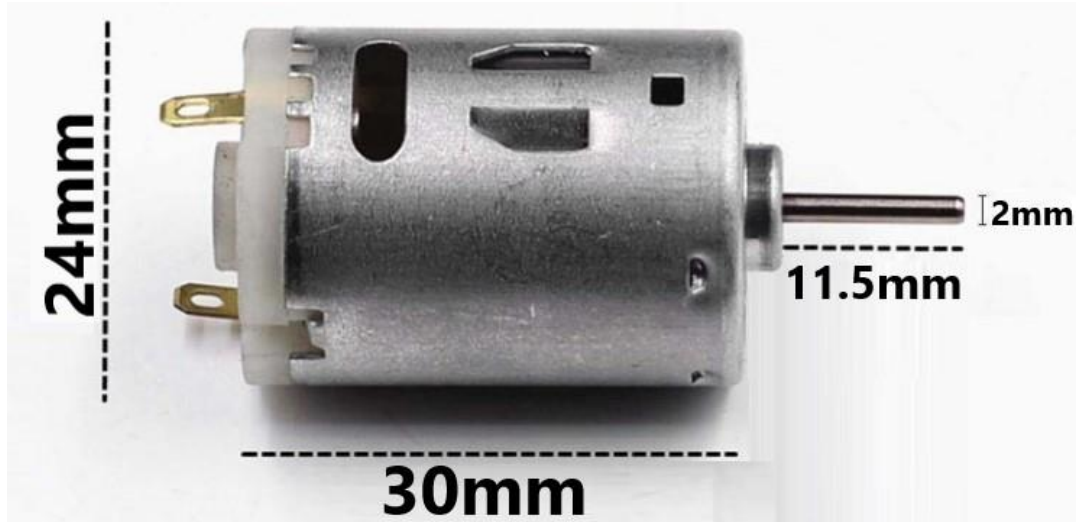

- Voltage: 3V-12V DC
- Speed: 7100-14000RPM
- Torque: 4.46mN.m
- Body Size (dia x length): 24 X 30MM
- Shaft Size (dia x length): 2 X 11.5MM
- Weight: 42g

RS-300 3V-6V High Speed DC Motor



Dimension

Specification

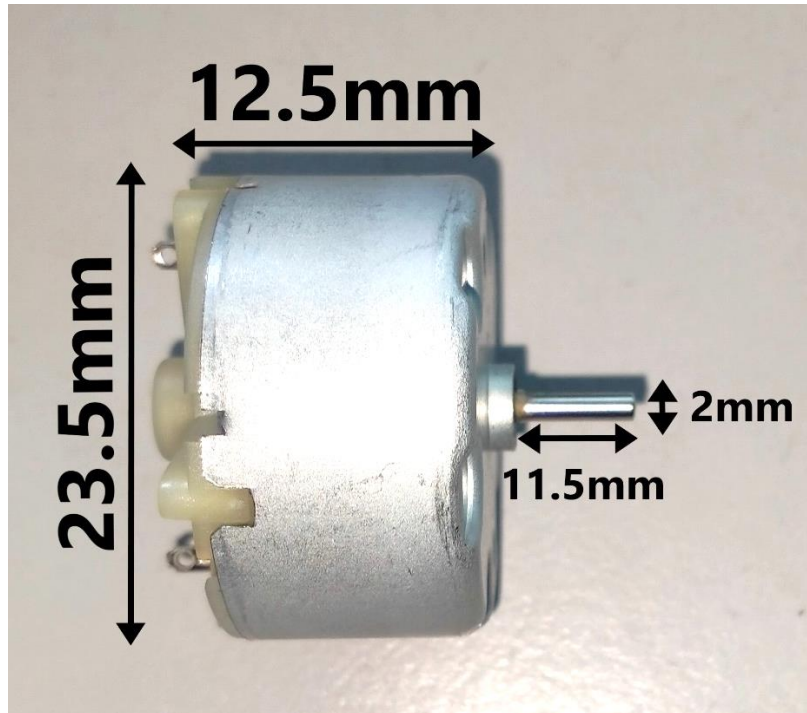

- Voltage: 3V-6V DC
- Speed: 1700-7300RPM
- Body Size (dia x length): 23.5 X 12.5MM
- Shaft Size (dia x length): 2 X 11.5MM
- Cable Length : 70mm
- Weight: 21g
- Mounting Screw Hole Diameter : 1mm/0.04";
- Screw Hole Distance : 18mm/0.7 18mm/0.7

RS-310 3V-6V High Speed DC Motor



Dimension

Specification

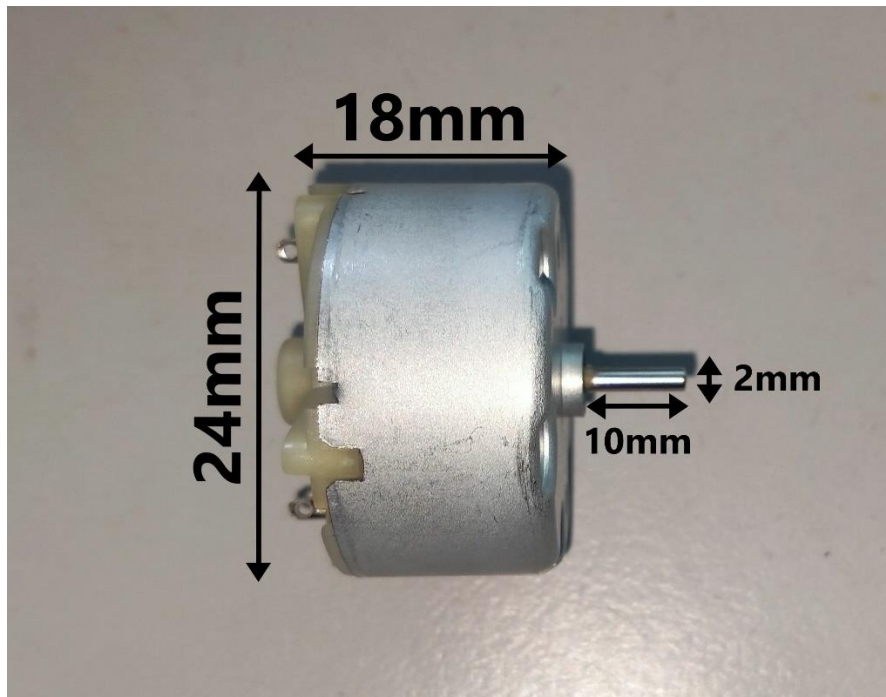

- Norminal Voltage: 3V-6V DC
- No Load Speed: 8600RPM @6V
- Torque:
- Body Size (dia x L): 24 X 18MM
- Shaft Size (dia x L): 2 X 10MM
- Weight: 15g

RS-365S 12V-24VDC High Speed DC Motor



Dimension

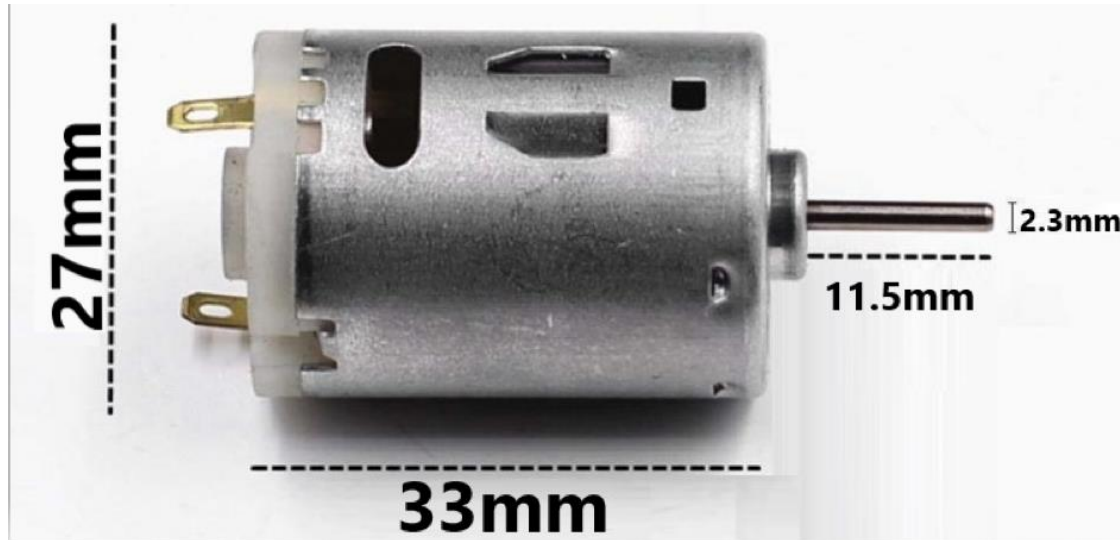

Specification

- Nominal Voltage: 12V-24V DC
- Rated voltage: 17V (9V runs at slow speed)
- Speed: 14700-28000rpm
- Body Size: 27 x 33mm
- Shaft Size: 2.3 X 11.5 mm
- Mounting hole: M2.5

RF-370CA 3V-12V DC Micro Motor



Dimension

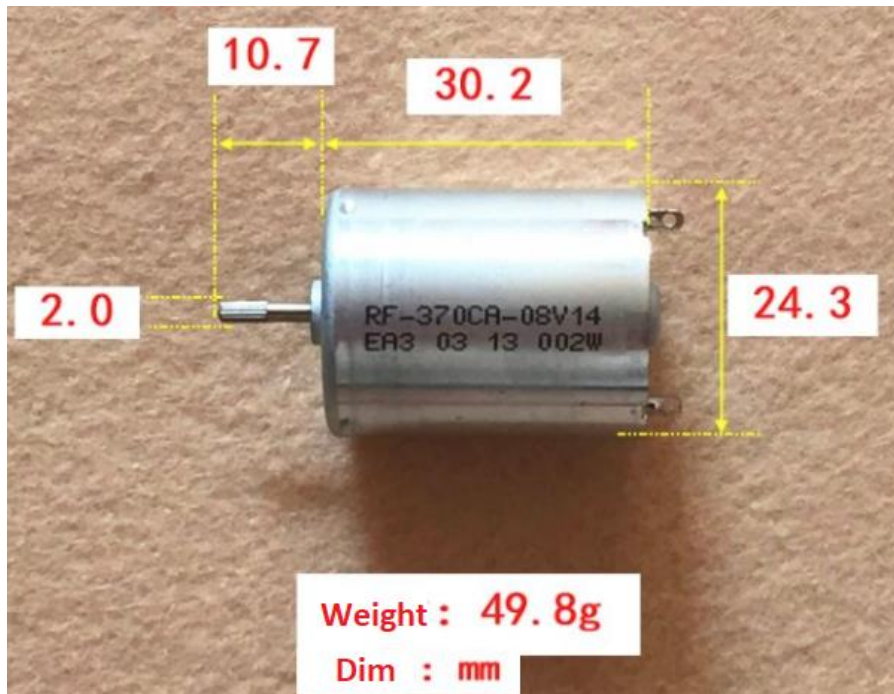

Specification

- Rated voltage: 8V DC
- No-load current: 20mA
- No-load speed: 7000 rpm
- Locked-rotor current: 0.6A
- Voltage range: 3-12V
- Voltage No-load current No-load speed Locked-rotor current
- 6V 18mA 5000 rpm 0.45A
- 12V 20mA 10200 rev/min 0.85A

RS-380 3V-12V High Speed DC Motor



Dimension

Specification

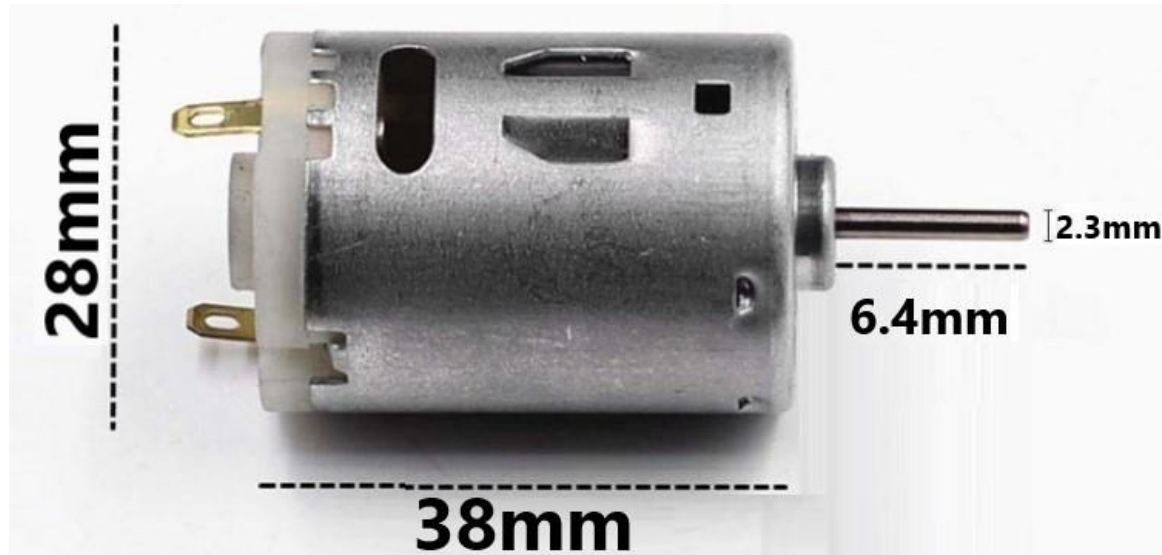

- Nominal Voltage: 3V-12V DC
- Speed: 17,000 - 33,000RPM
- Body Size: 28 x 38mm
- Shaft Size : 2.3 X 6.4 mm

RS-385 12V-24VDC High Speed DC Motor



Dimension

Specification

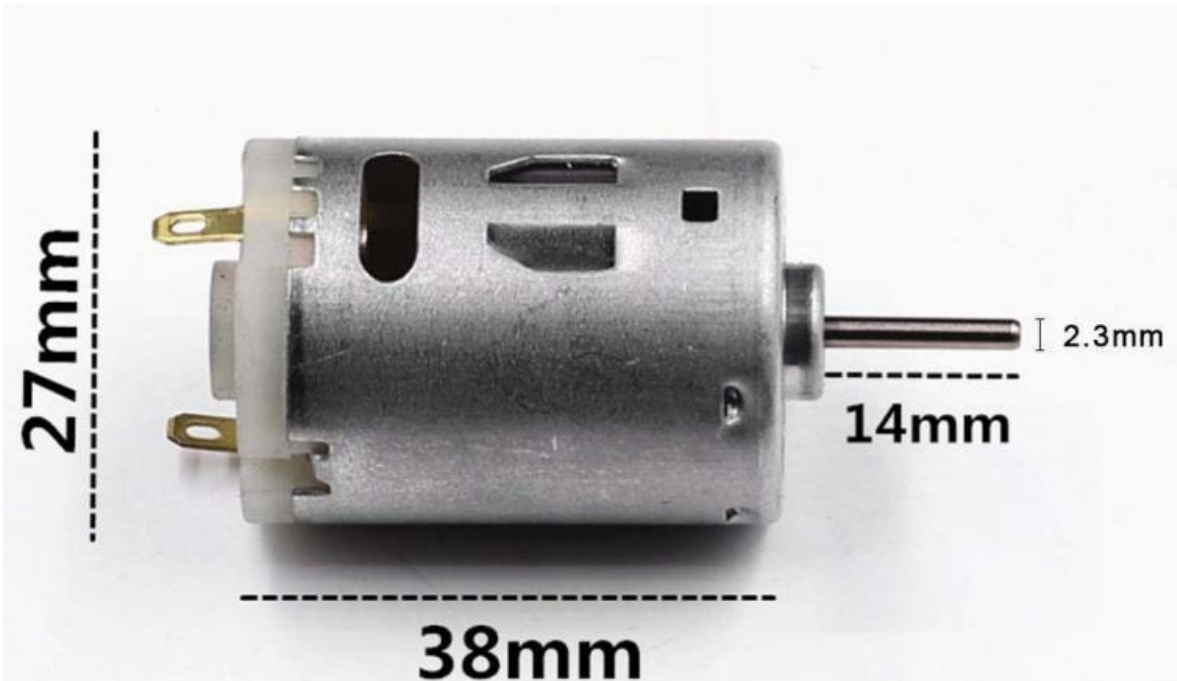

- Voltage: 12-24V DC
- Rated voltage: 14.4V DC
- Speed: 12000-15000rpm
- Weight: 70g
- Shaft Size: 2.3 X 14 mm

RS-390 6V-12V High Speed DC Motor



Dimension

Specification

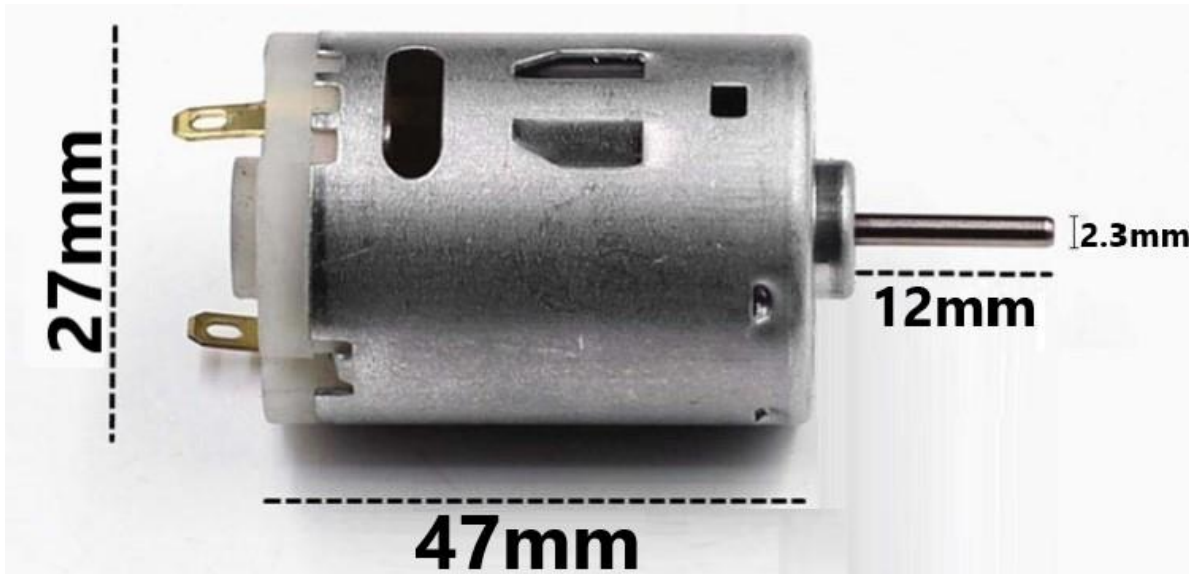

- Voltage: 6-12V
- Speed: 6500-13000RPM
- Body Size: 27x47mm
- Shaft Size: 2.3 X 12mm

RS-395 6V-12V High Speed DC Motor



Dimension

Specification

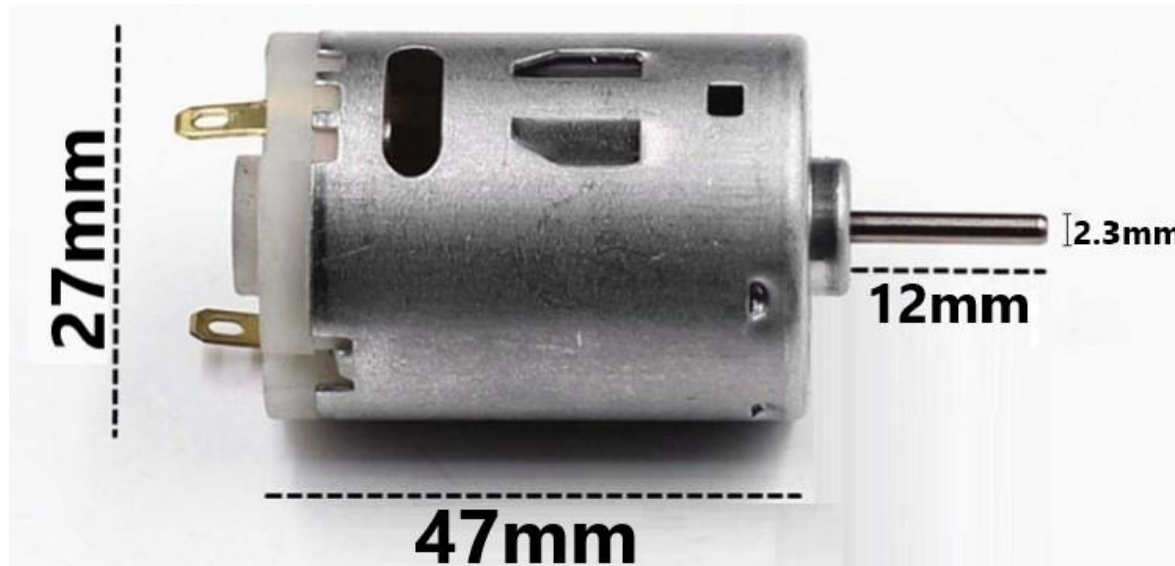

- Voltage: 6-12V
- Speed: 5800-11600RPM
- Body Size: 27x47mm
- Shaft Size: 2.3 X 12mm
- Hole Screw:M2.5
- Weight: 88g

RS-500 3-12VDC High Speed DC Motor



Dimension

Specification

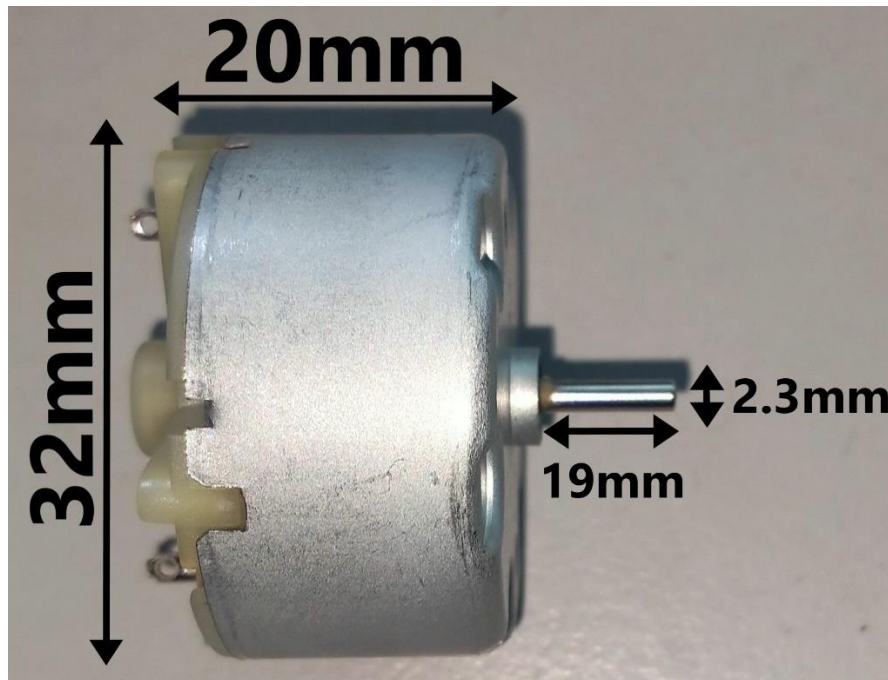

- Voltage: 3-12V
- Speed: 2000-12000RPM
- Body Size (dia x length):
32x20mm
- Shaft Size (dia x length): 2.3 X
19mm

RS-545 12-24VDC High Speed DC Motor



Dimension

Specification

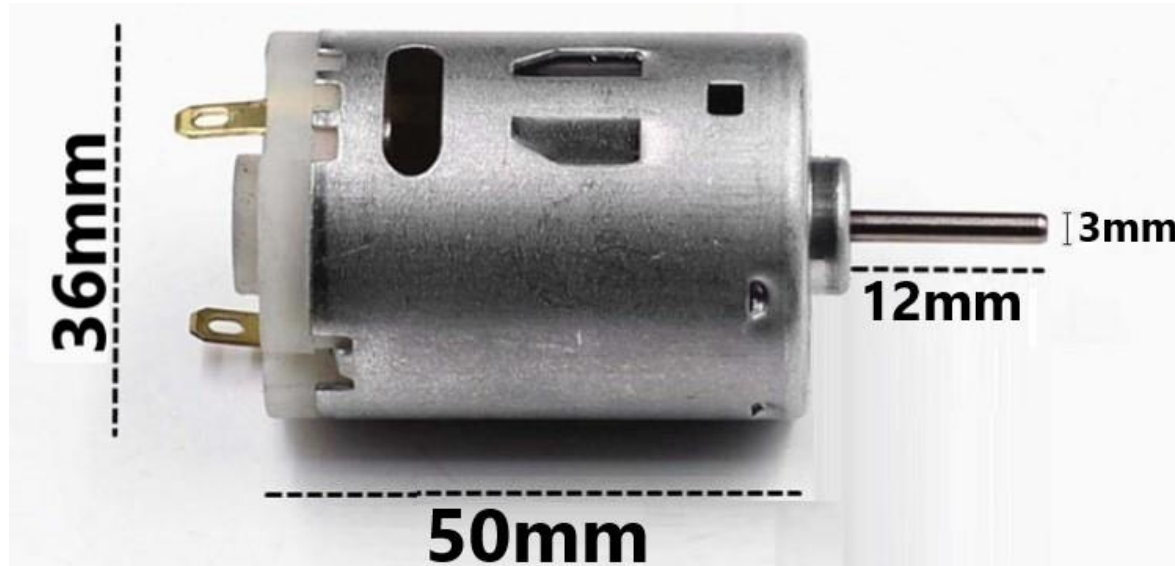

- Voltage: 12V-24V
- Speed: 1000-30000rpm
- Body Size: 36x50mm
- Weight: 156g
- Shaft Size (dia x length): 3 X 12mm

RS-550 12-24VDC High Speed DC Motor



Dimension

Specification

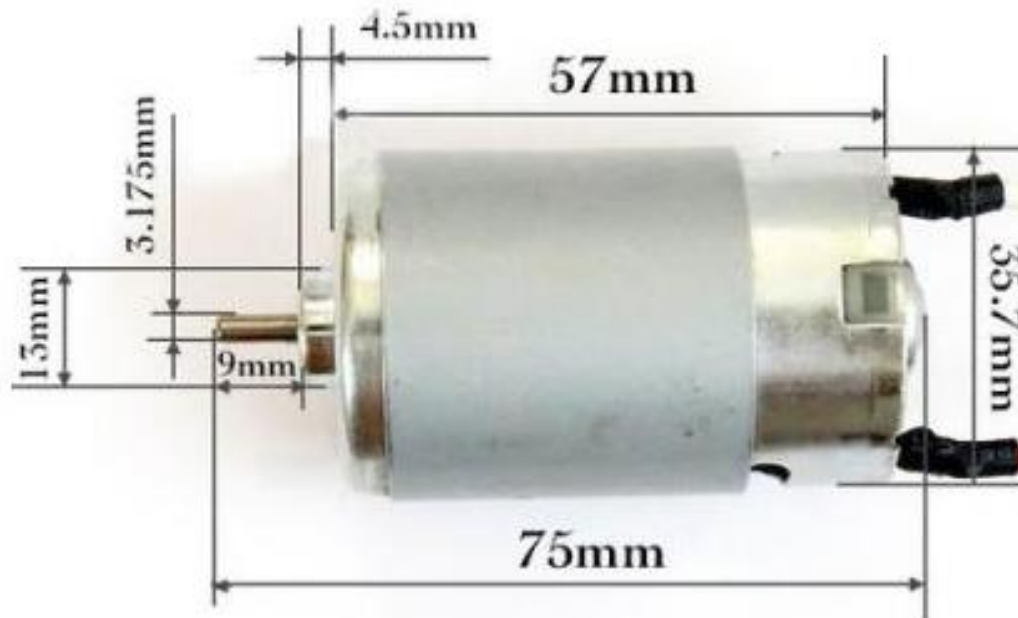

- Voltage: 12V-24V DC
- Speed: 3,550 RPM
- Torque: 330gf.cm
- Body Size: 35.7mm x 57mm
- Shaft Size: 3.175mm x 9mm

RS-555 12-24VDC High Speed DC Motor



Dimension

Specification

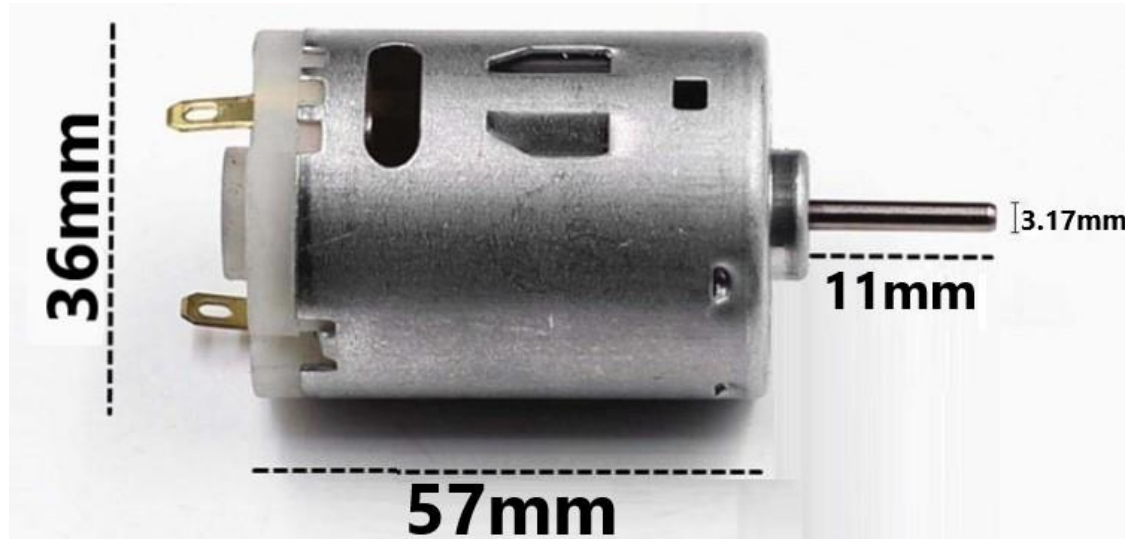

- Voltage: 12V-24V DC
- Speed: 6000-12000rpm
- Body Size: 36mm x 57mm
- Shaft Size: 11mm x 3.17mm
- Hole: M3

775 12-24V DC High Power DC Motor High Torque



Dimension

Specification



- Motor model: 775
- Rated voltage: 12-24VDC
- Speed RPM:3000-6000
- Outer diameter: 42mm
- Height: 66.5mm
- Shaft length: 16mm
- Shaft diameter: 5mm

795 12-24V DC High Power DC Motor High Torque



Dimension

Specification



- Motor model: 795
- Rated voltage: 12-24VDC
- Speed RPM:3000-6000
- Outer diameter: 42mm
- Height: 70.5mm
- Shaft length: 16mm
- Shaft diameter: 5mm

895 12-24V DC High Power DC Motor High Torque



Dimension

Specification



- Motor model: 895
- Rated voltage: 12-24VDC
- Speed RPM:3000-6000
- Outer diameter: 48mm
- Height: 72mm
- Shaft length: 16mm
- Shaft diameter: 5mm