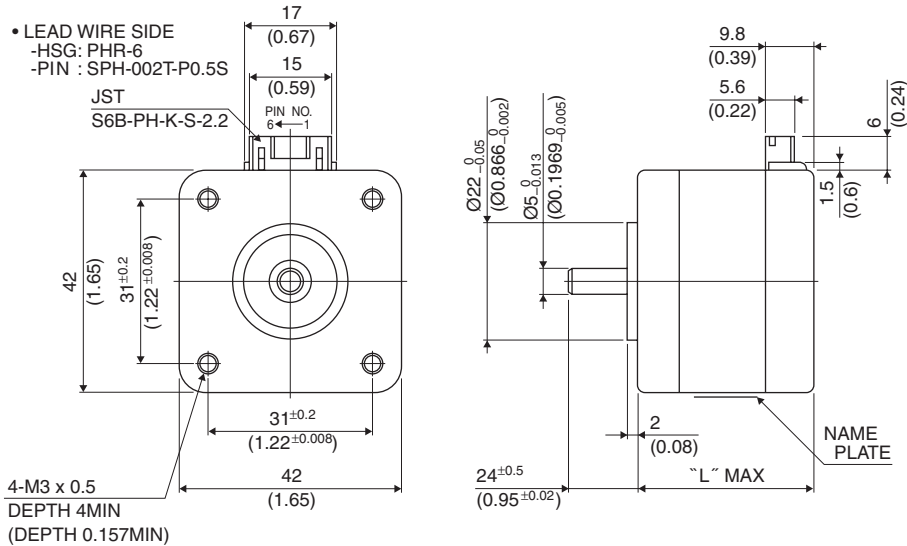

## ■ 外觀図 Outline

 UNIT:  $\frac{\text{mm}}{\text{(inch)}}$ 

結線表 PIN NO. VS PHASE

相 (PHASE)	A	A COM	$\bar{A}$	B	B COM	$\bar{B}$
ピン番号 (PIN NO.)	4	5	6	3	2	1

	“L”
17PM-J7**	26 (1.02)
17PM-J2**	30 (1.18)
17PM-J0**	34 (1.34)
17PM-J3**	38 (1.50)
17PM-J1**	42 (1.65)
17PM-J4**	48 (1.89)



Hybrid

## ■ 仕様 Specifications

型式	ステップ角	ドライブ方式	定格電流	巻線抵抗	ホールディングトルク	インダクタンス	ロータイナーシャ	ディテントトルク	質量
Model	Step Angle	Drive Sequence	Rated Current	Resistance	Holding Torque	Inductance	Rotor Inertia	Detent Torque	Mass
	(deg)		(A)	(Ohms)	(mNm)	(mH)	(g·cm <sup>2</sup> )	(mNm)	(g)
17PM-J049U	1.8	UNI-POLAR	1	3.1	160	3.3	26	9.8	200
17PM-J064U	1.8	UNI-POLAR	0.6	8.3	160	8.2	26	9.8	200
17PM-J142U	1.8	UNI-POLAR	1.4	2.3	250	3.1	44	8.3	300
17PM-J149U	1.8	UNI-POLAR	1	4.3	250	5.9	44	8.3	300
17PM-J249U	1.8	UNI-POLAR	0.8	2.7	85	2.6	17	3.9	180
17PM-J264U	1.8	UNI-POLAR	0.6	6.9	85	6.7	17	3.9	180
17PM-J342U	1.8	UNI-POLAR	1.4	2.0	210	2.4	35	7.9	250
17PM-J349U	1.8	UNI-POLAR	1	3.6	210	4.7	35	7.9	250
17PM-J442U	1.8	UNI-POLAR	1.4	2.8	320	3.3	54	14.7	350
17PM-J449U	1.8	UNI-POLAR	1	4.9	320	6.3	54	14.7	350
17PM-J749U	1.8	UNI-POLAR	0.9	2.2	35	1.4	8	2.8	150
17PM-J764U	1.8	UNI-POLAR	0.6	5.6	35	0.9	8	2.8	150
17PM-J049B	1.8	BI-POLAR	0.7	6.2	205	13.0	26	9.8	200
17PM-J142B	1.8	BI-POLAR	1	4.6	320	12.5	44	8.3	300
17PM-J249B	1.8	BI-POLAR	0.6	5.4	120	10.4	17	3.9	180
17PM-J342B	1.8	BI-POLAR	0.9	4.0	260	9.7	35	7.9	250
17PM-J442B	1.8	BI-POLAR	0.9	5.6	390	13.2	54	14.7	350
17PM-J749B	1.8	BI-POLAR	0.6	4.4	53	5.8	8	2.8	150

# ■ トルク・スピード特性 Torque/Speed Characteristics

Model No: 17PM-J049U,M064U,J049B  
 Driver: Chopper Dual  
 Supply Voltage: 24.0 (Volt)

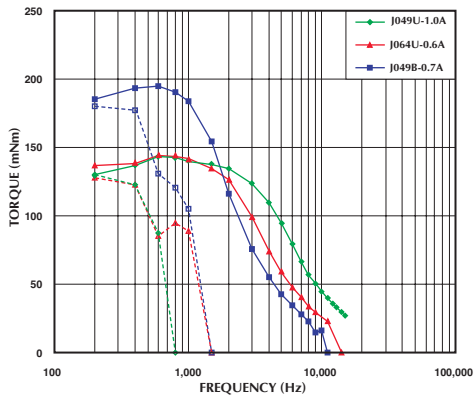

Model No: 17PM-J142U,J149U,J142B  
 Driver: Chopper Dual  
 Supply Voltage: 24.0 (Volt)

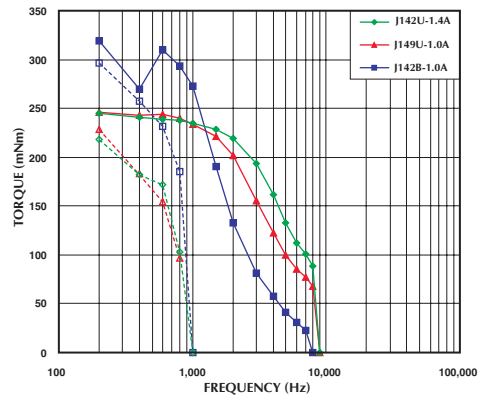

Model No: 17PM-J249U,J264U,J249B  
 Driver: Chopper Dual  
 Supply Voltage: 24.0 (Volt)

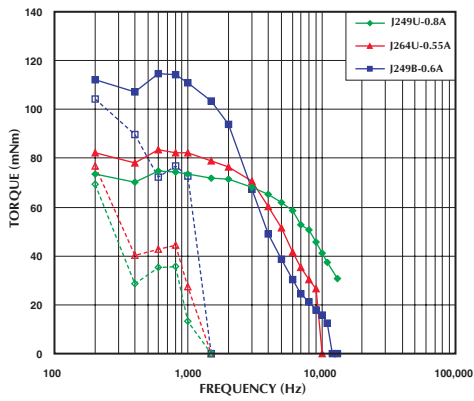

Model No: 17PM-J342U,J349U,J342B  
 Driver: Chopper Dual  
 Supply Voltage: 24.0 (Volt)

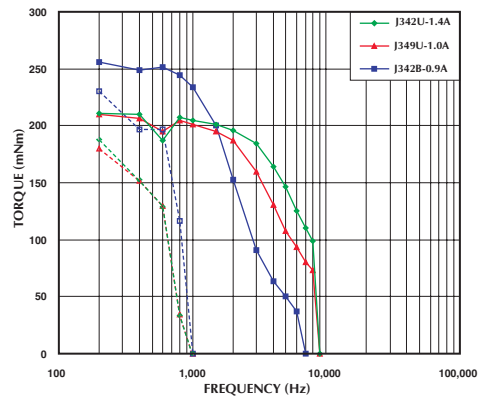

Model No: 17PM-J442U,J449U,J442B  
 Driver: Chopper Dual  
 Supply Voltage: 24.0 (Volt)

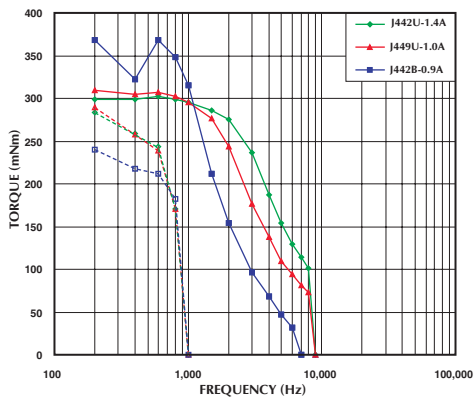

Model No: 17PM-J749U,J764U,J749B  
 Driver: Chopper Dual  
 Supply Voltage: 24.0 (Volt)

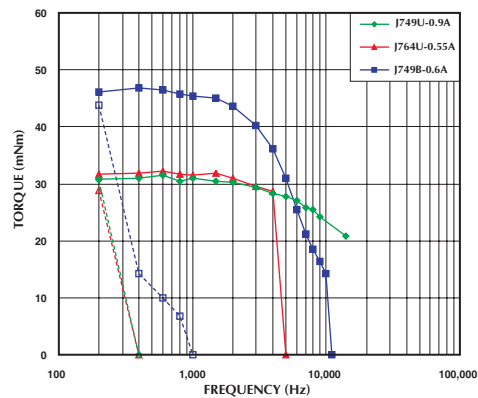

— : PULL OUT  
 - - - : PULL IN